

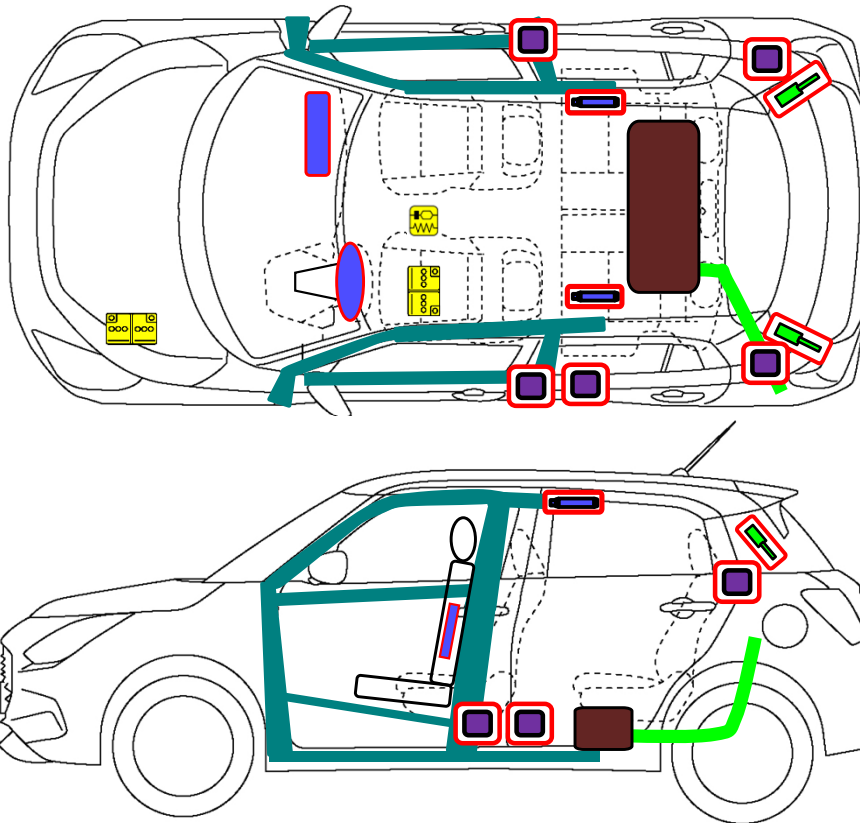

SUZUKI SWIFT

Z12E engine with mild hybrid system model
5 doors / 5 seats
2023-12



	Airbag		Stored gas inflator		Seat belt pretensioner		Sensing and Diagnostic Module (SDM)		Gas strut/Preloaded spring
	High strength zone		Battery low voltage		Fuel tank				
					ID No.	Version No.	Version date	Page	
					AOL312	01	12/ 2023	1 / 4	

1. Identification / Recognition

- Location of vehicle badges



2. Immobilization / Stabilization / Lifting

- Immobilize the vehicle



1. Chock the wheels and engage the parking brake.

Manual Transmission Model

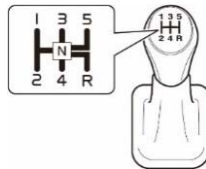

CVT Model

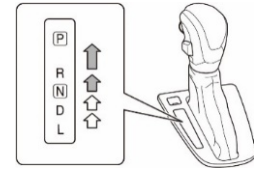

2. Move the shift lever to the park (P) position.

- Lifting points

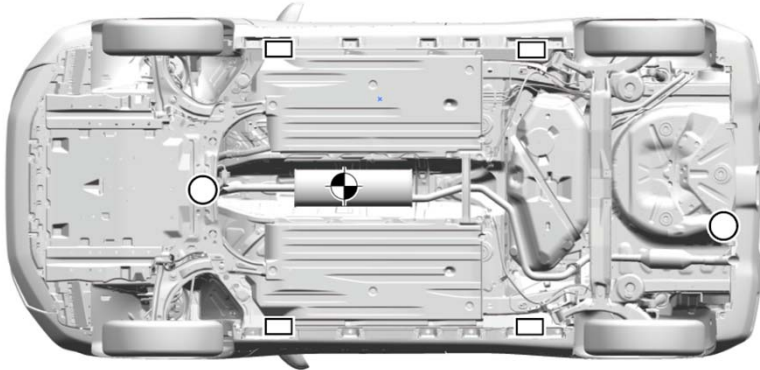

- Floor jack position
- Position of center of gravity without load in vehicle
- Support position for frame contact hoist and safety stand



Do not place supports such as wooden blocks or life pillows under the exhaust and fuel systems. Doing so can cause fuel leakage and fire.

3. Disable Direct Hazards / Safety Regulations

- If any of the following systems are required to be operated, operate them BEFORE disconnecting the battery.

Power door lock Power window Back door

When the 12 V battery is disconnected, electrical components cannot be operated.

ID No.

AOL312

Version No.

01

Version date

12/ 2023

Page

2 / 4

- Perform procedure 1 or 2 to completely shut off the vehicle.

Procedure 1:

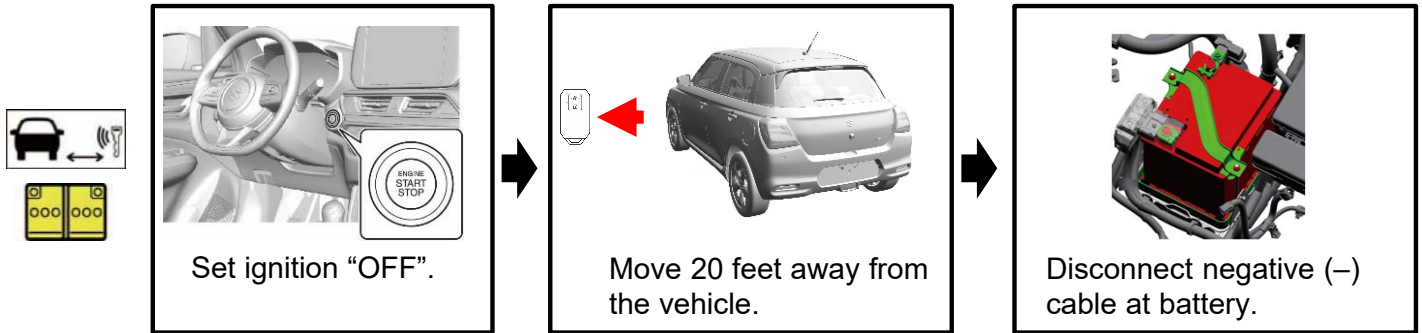

Procedure 2:

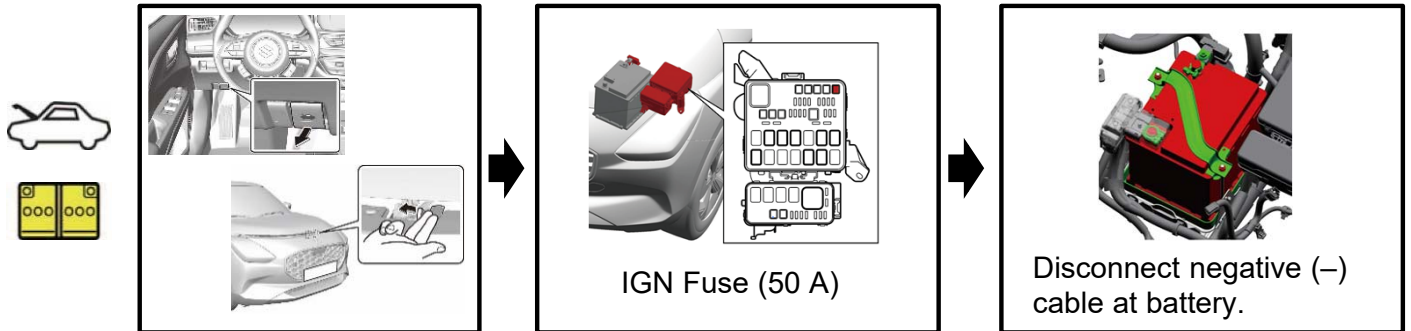

Access to 12 V Battery:

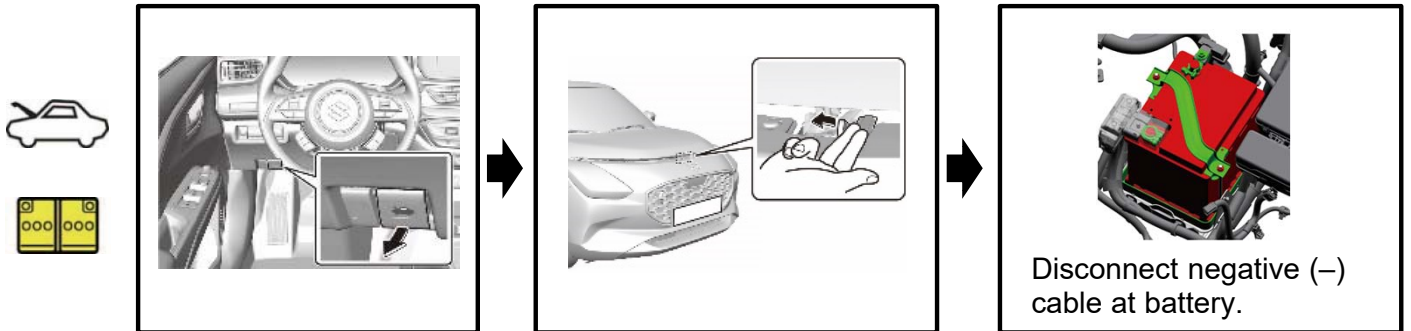

4. Access to the Occupants

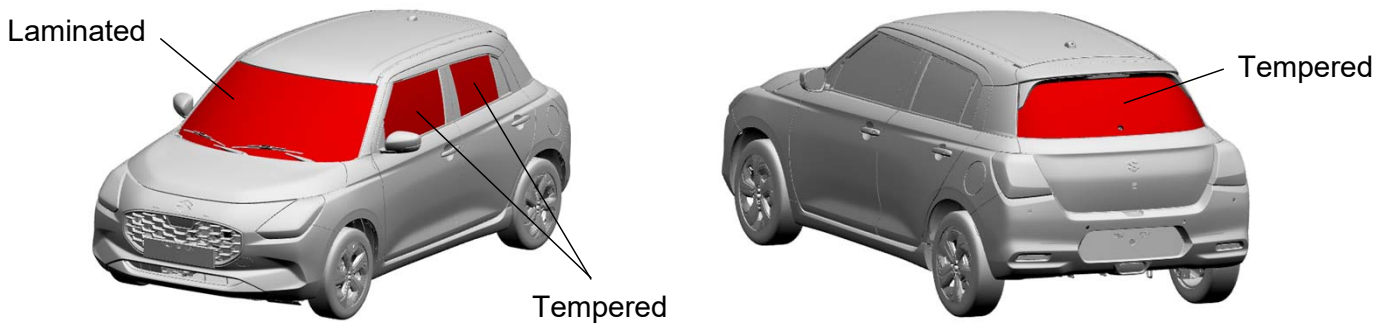

ID No.	Version No.	Version date	Page
AOL312	01	12/ 2023	3 / 4

5. Stored Energy / Liquids / Gases / Solids

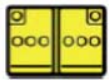

12V battery

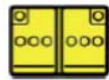

Lithium-ion battery



Fuel tank: 37 L



Always wear appropriate personal protective equipment (PPE) when dealing with any of these items.

6. In Case of Fire



Lithium-ion batteries can self-ignite or re-ignite after fire-fighting measures!

7. In Case of Submersion



Work on the vehicle only after the vehicle has been pulled out of the water.

8. Towing / Transportation / Storage

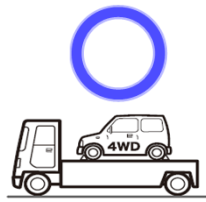
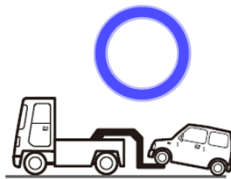

Lithium-ion batteries can self-ignite or re-ignite after fire-fighting measures!

Store the vehicle at a safe distance (15 m (49.2 ft) or more) from other vehicles.

9. Important Additional Information

For further details, please refer to "Emergency Response Guide".

10. Explanation of Pictograms Used

For further details, please refer to "Emergency Response Guide".

ID No.

Version No.

Version date

Page

AOL312

01

12/ 2023

4 / 4