

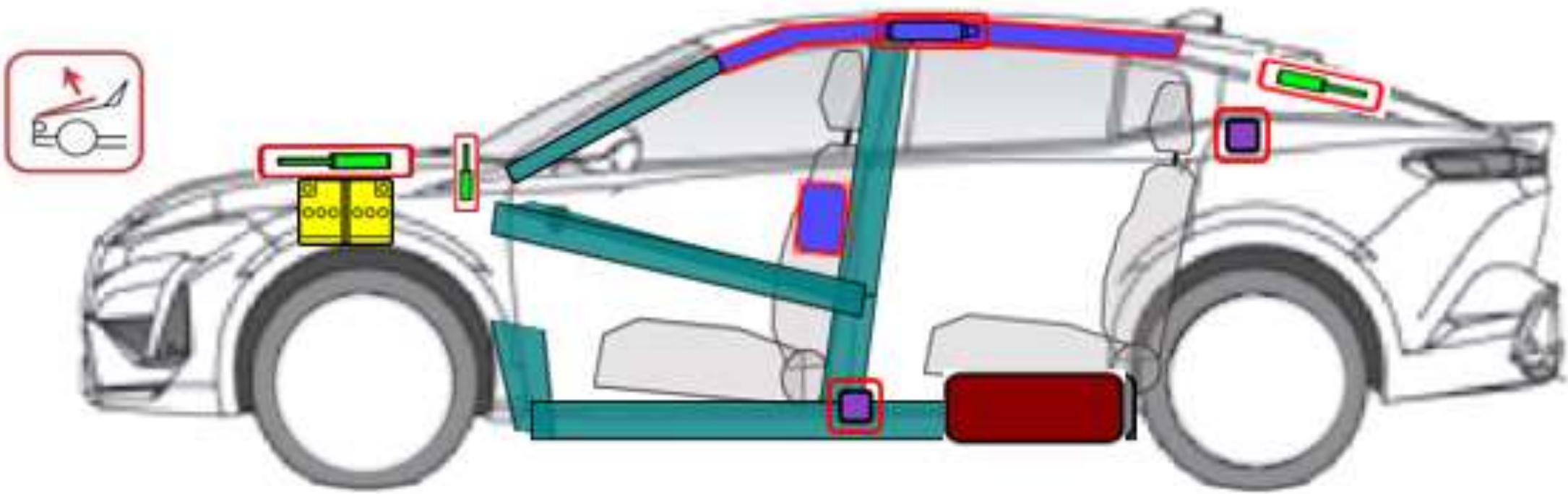

Peugeot 408

5 doors/ 5 seats/ SUV
(12/2022/ ->)

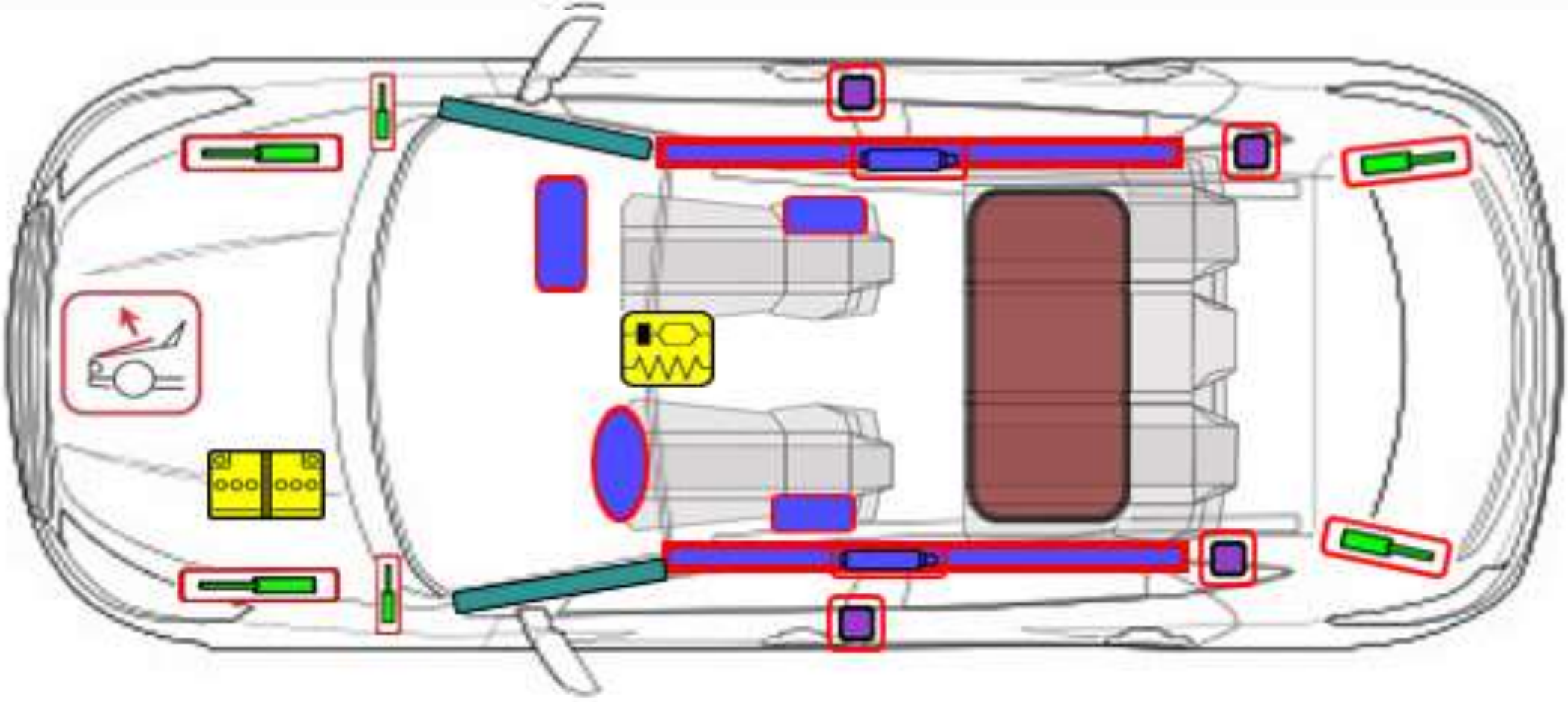

	Airbag		Stored gas inflator		Seat belt pretensioner		SRS control unit		Pedestrian protection active system
			Gas strut / Preloaded spring		High strength zone				
	Battery low voltage								
					Fuel tank content gasoline / ethanol				

1. Identification / recognition



2. Immobilisation / stabilisation / lifting

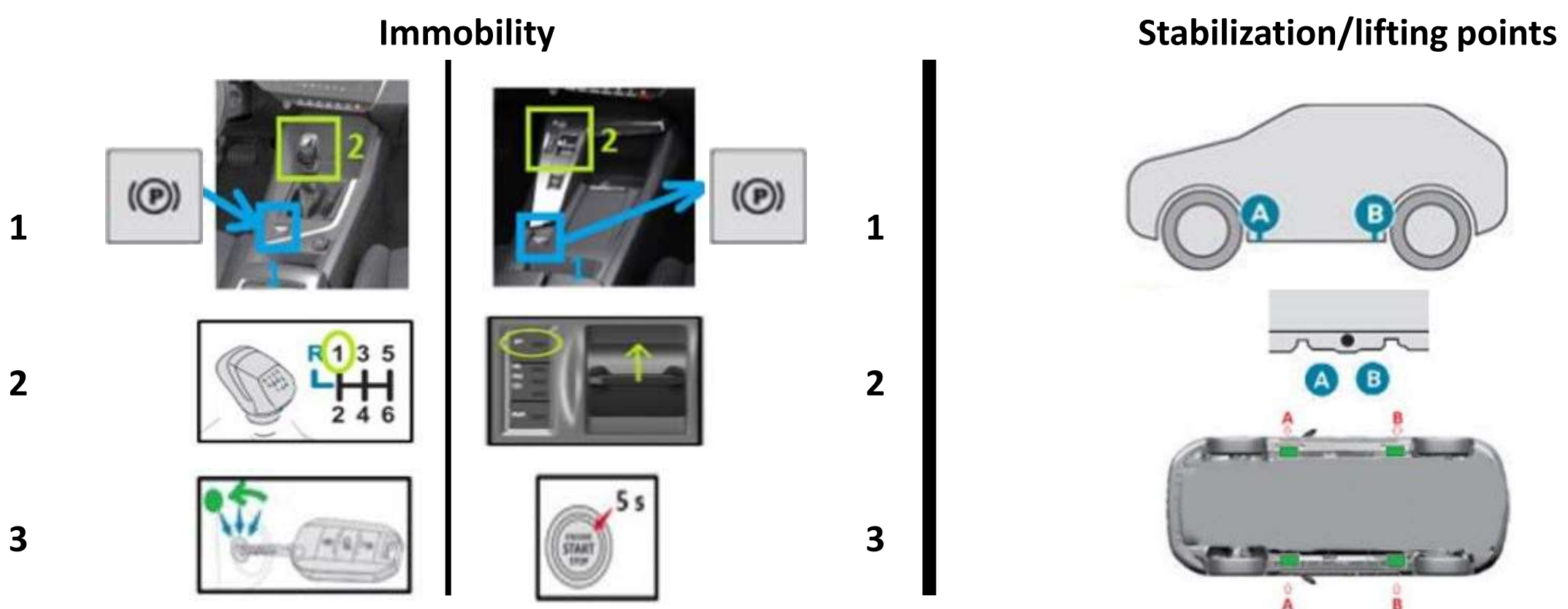

3. Disable direct hazards / safety regulations

Main disabling method

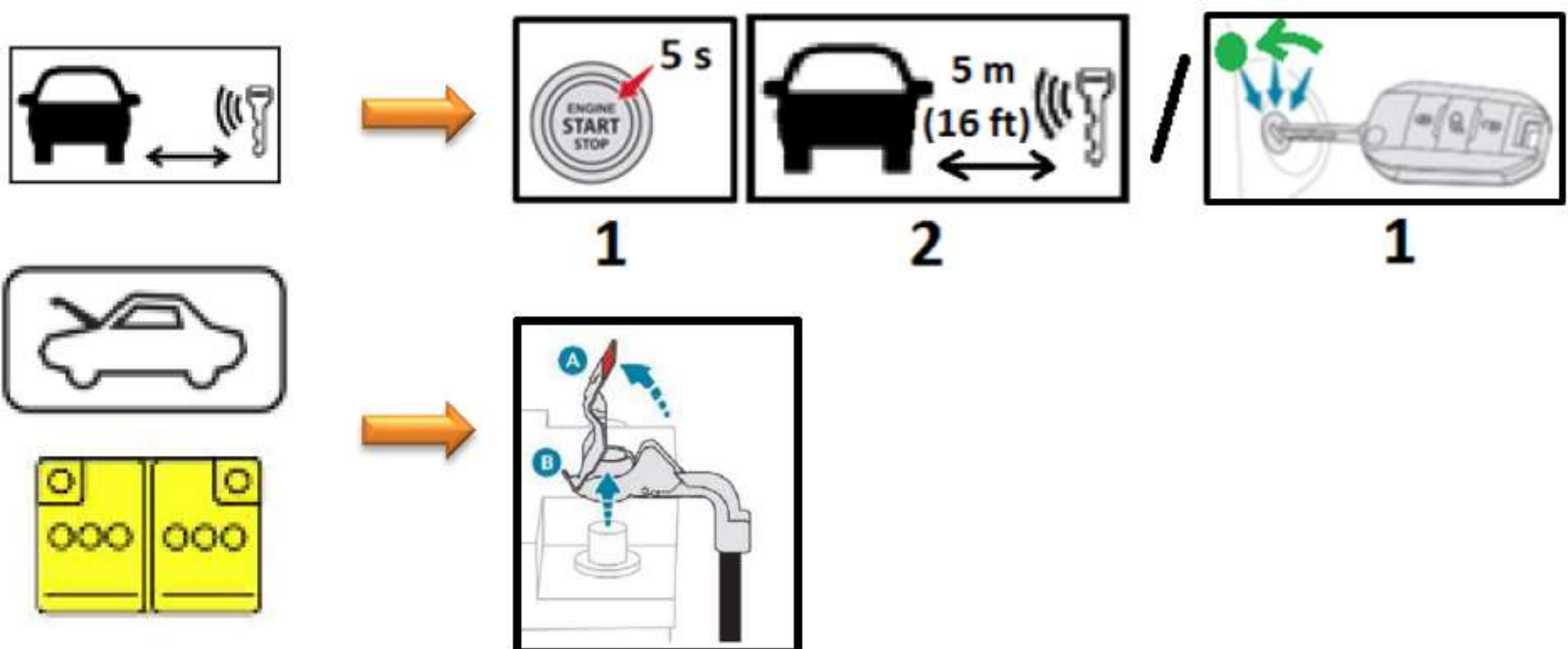

4. Access to the occupants



5. Stored energy / liquids / gases / solids

	12V	
	52L	

8. Towing / transportation / storage

Location front hook



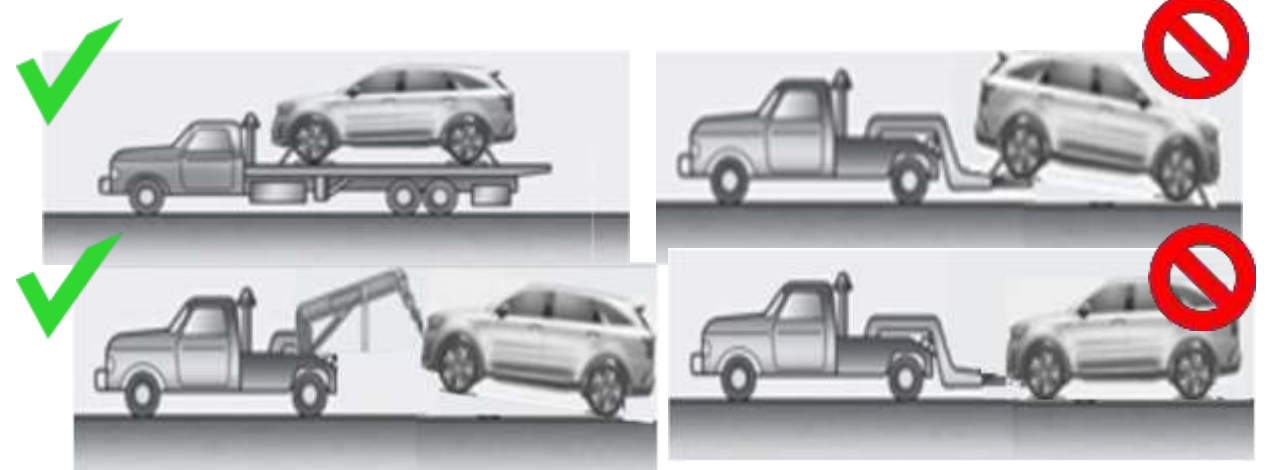
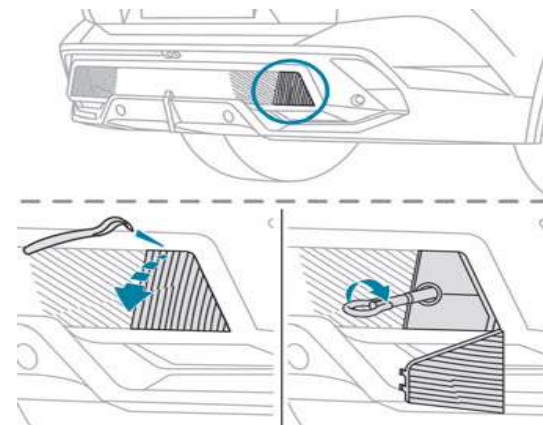
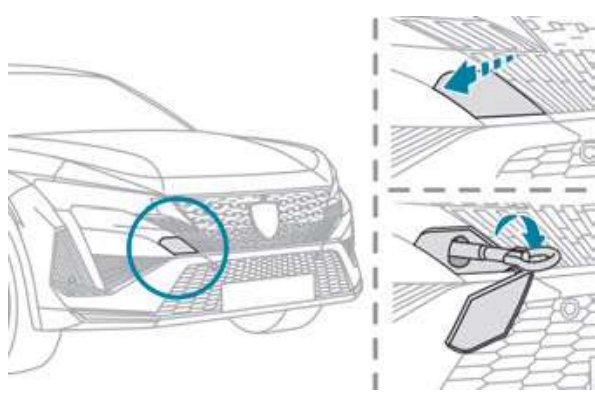

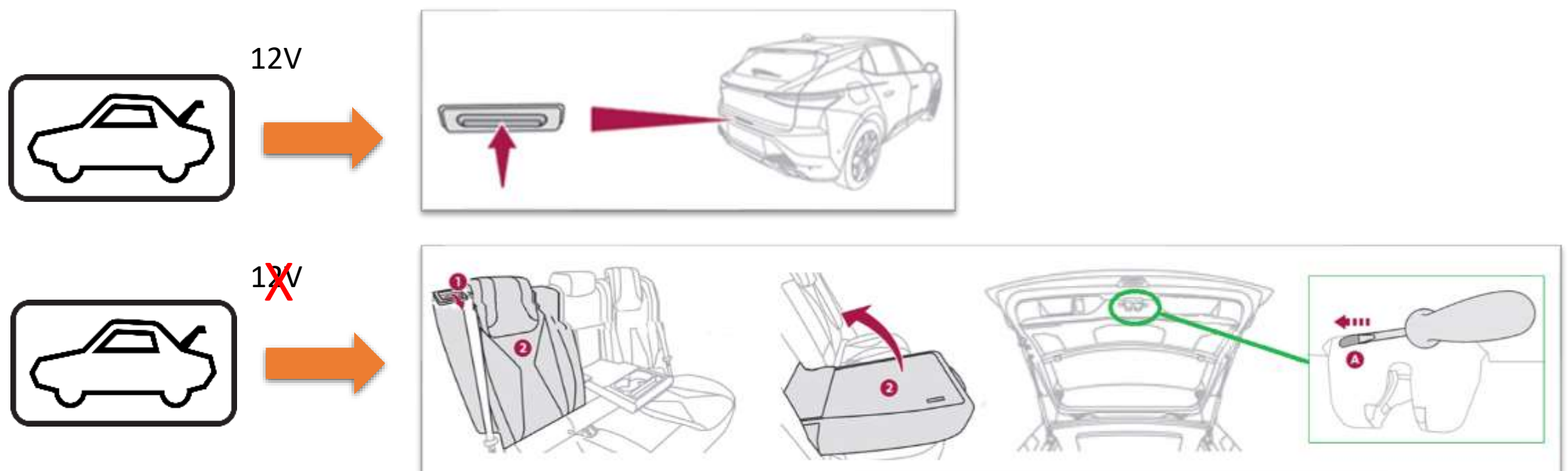

Location rear hook

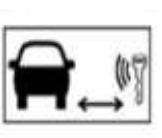

9. Important additional information



10. Explanation of pictograms used

	Remove smart key		Flammable
	General warning sign		Hazardous to the human health
	Vehicle on fuel of liquid group 2		Explosive