

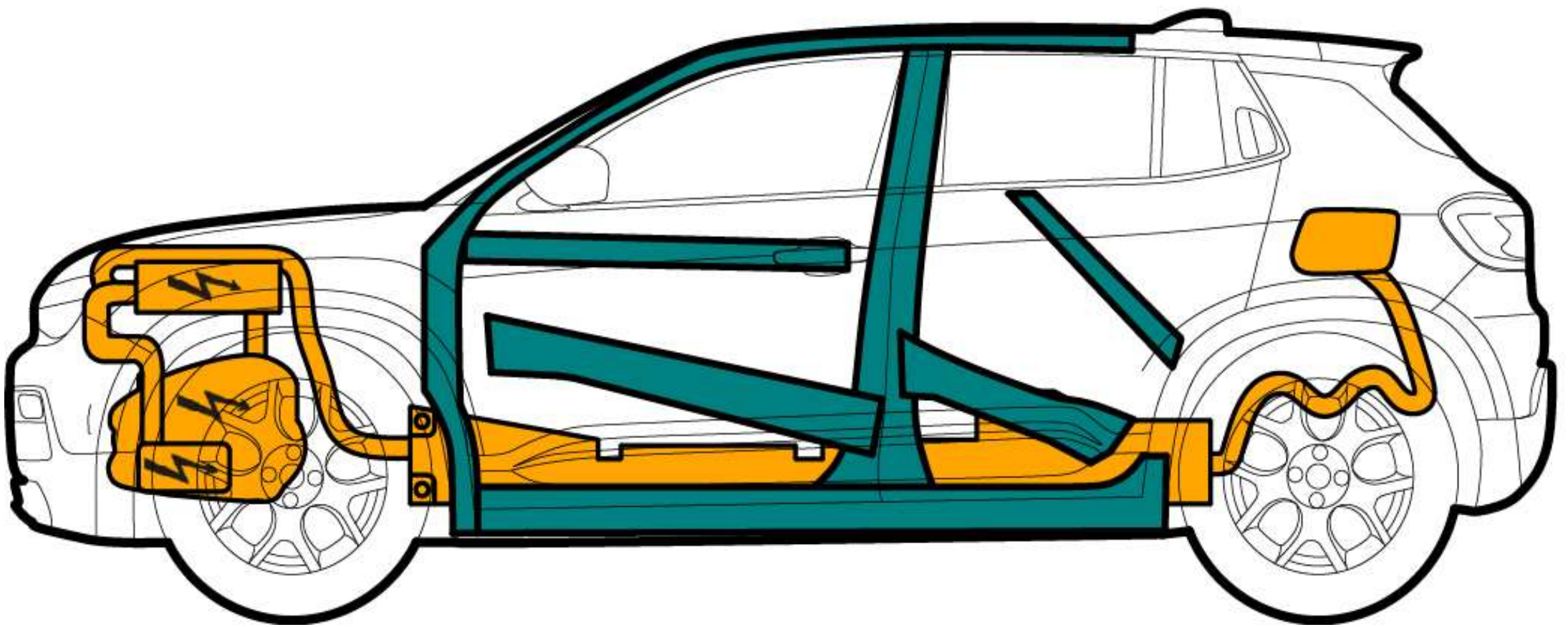

Jeep Avenger

5 doors/ 5 seats/ SUV
(2023/ ->)

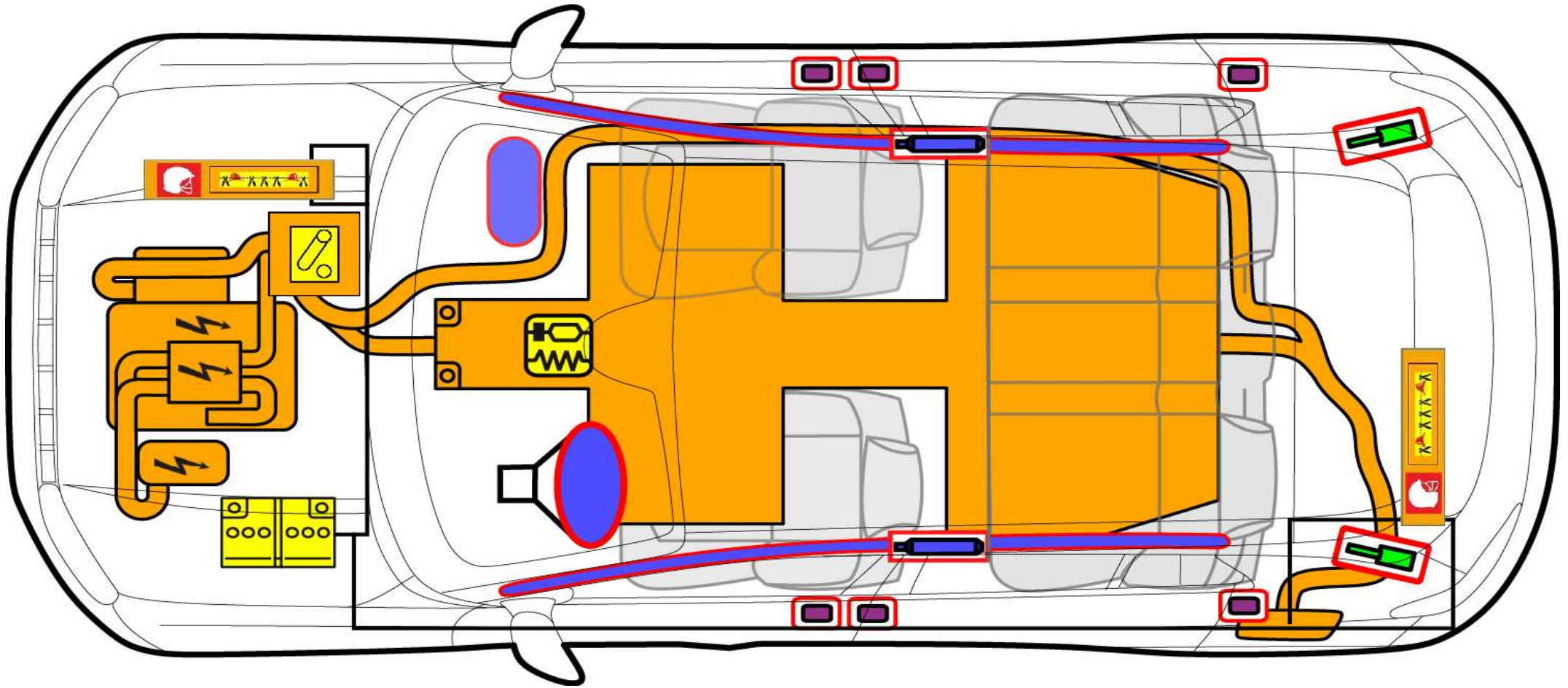

| | | | | | | | | | |
|--|----------------------------|--|--|--|--------------------|--|--|--|--|
| | Airbag | | Stored gas inflator | | SRS control unit | | | | |
| | | | Gas strut / Preloaded spring | | High strength zone | | | | |
| | Battery low voltage | | | | | | | | |
| | Battery pack, high-voltage | | High voltage power cable | | | | | | |
| | Cable cut | | Low voltage device that disconnects high voltage | | | | | | |

| STELLANTIS | ID N° | Version N° | Version date | Page |
|------------|------------------------------------|------------|--------------|------|
| | JEEP_Avenger__SUV_2023_5d_Electric | 1 | 21.03.2024 | 1/5 |

1. Identification / recognition



LACK OF ENGINE NOISE DOES NOT MEAN VEHICLE IS OFF, SILENT MOVEMENT OR INSTANT RESTART CAPABILITY EXISTS UNTIL VEHICLE IS FULLY SHUT DOWN. WEAR APPROPRIATE PPE.

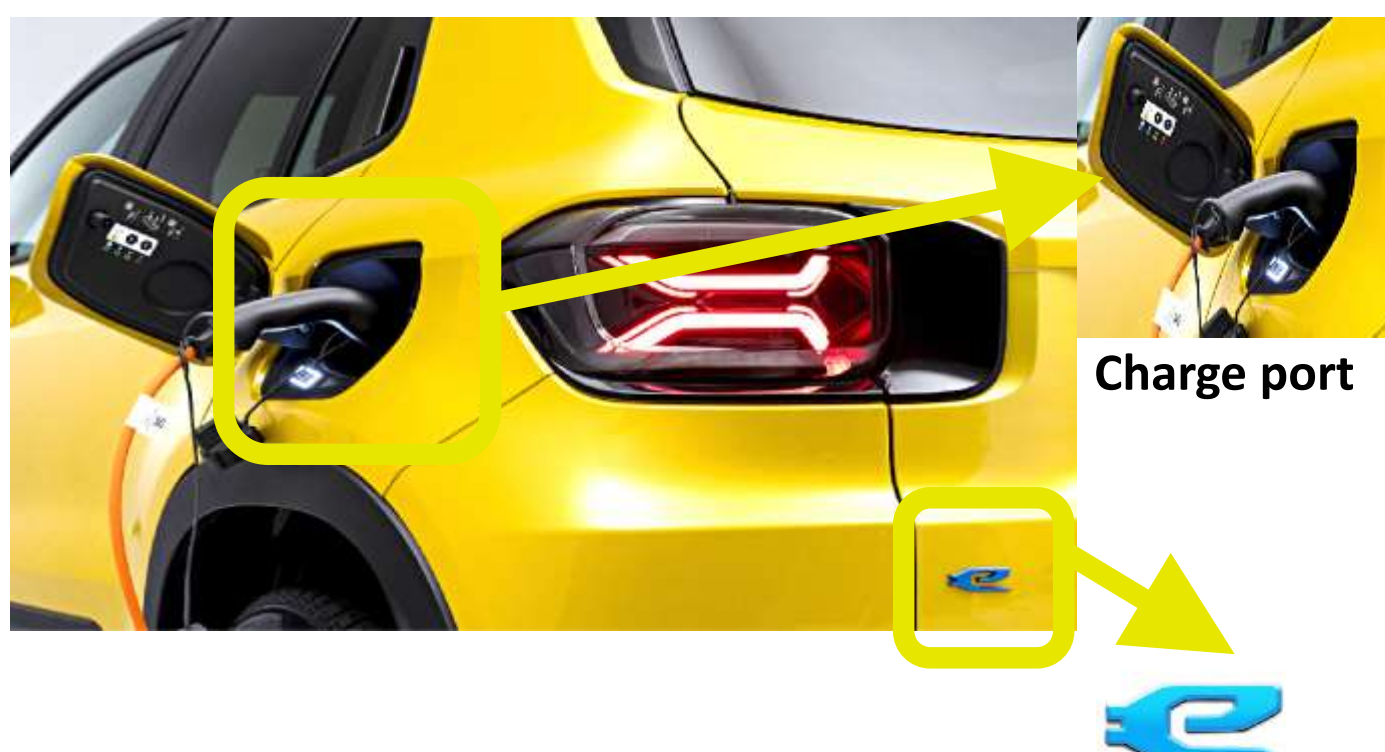

2. Immobilisation / stabilisation / lifting

Immobility

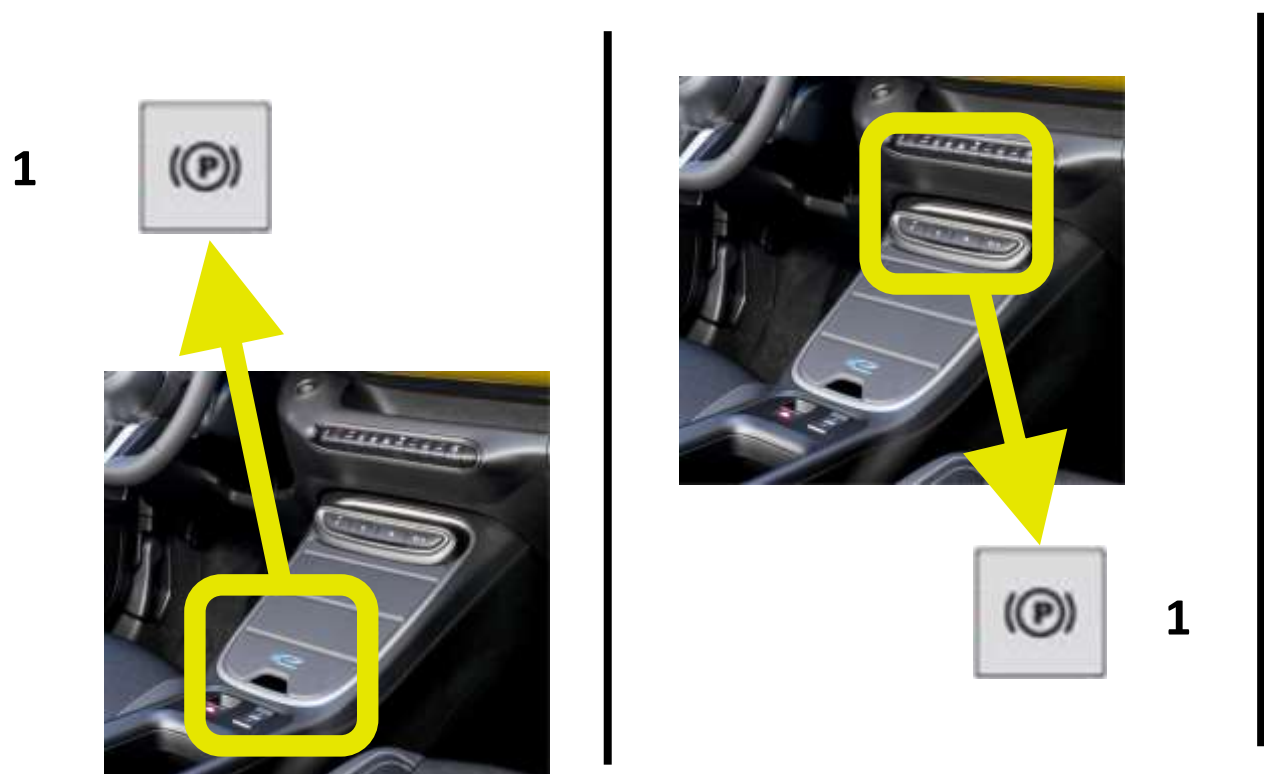

Stabilization/lifting points

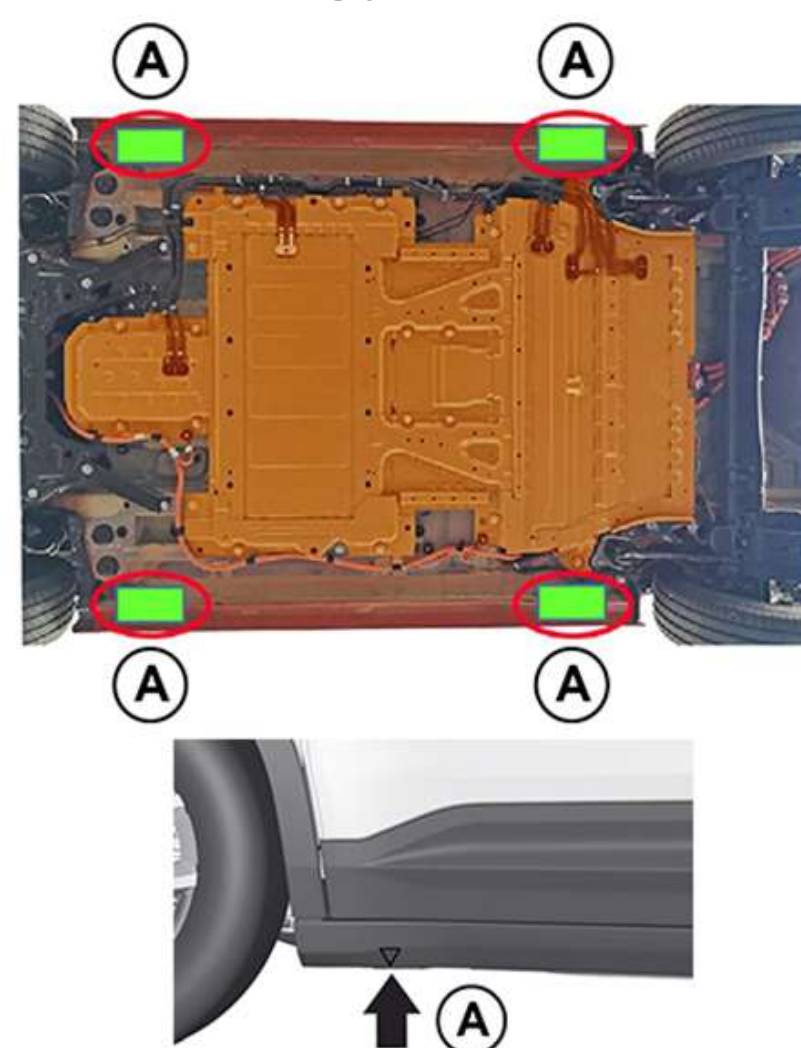

Do not place cribbing such as wooden blocks or rescue air lifting bags under the fuel system or high voltage power cables. Doing so may result in fuel leaks, fire, or electric shock.

3. Disable direct hazards / safety regulations

Main disabling method

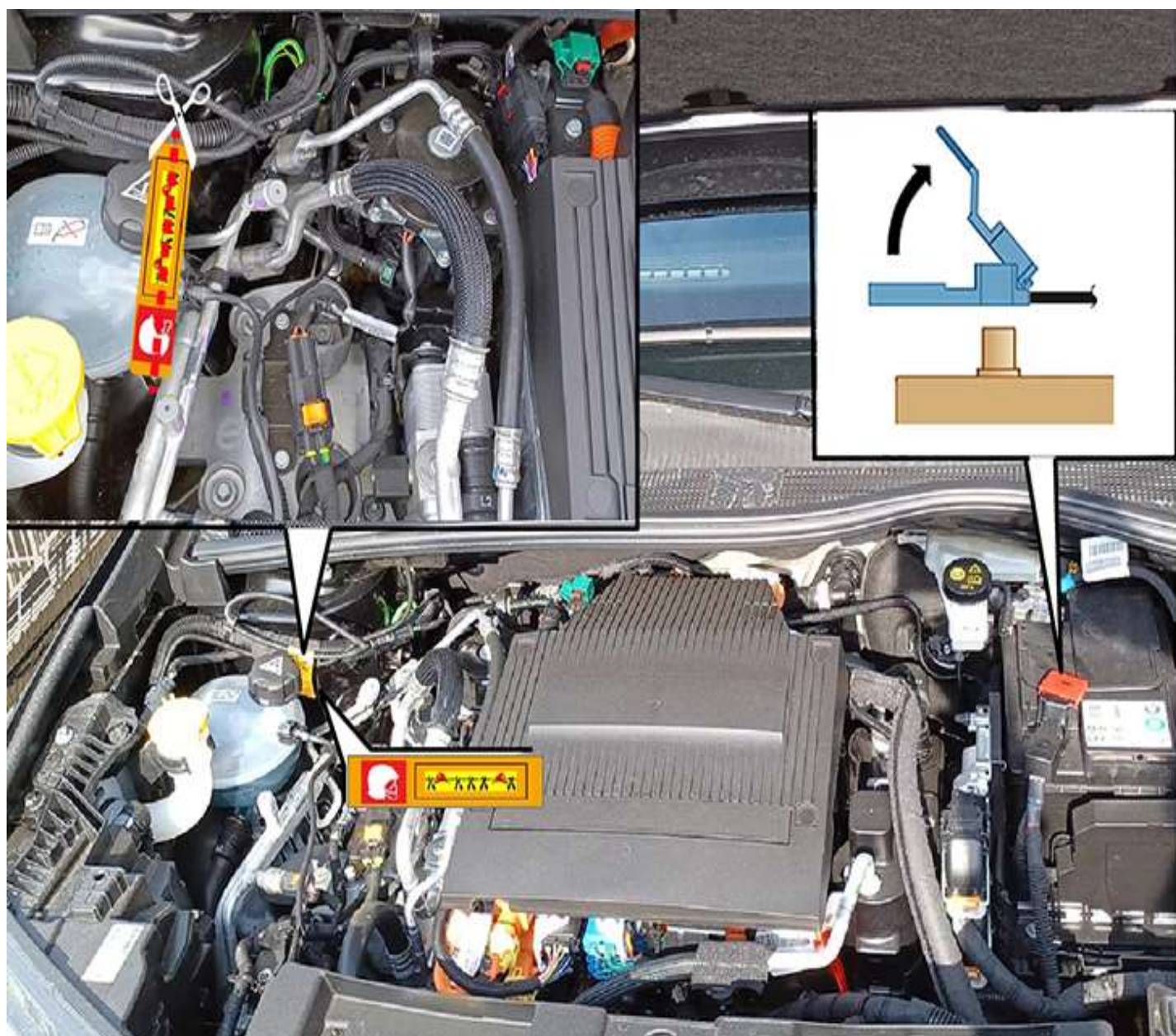
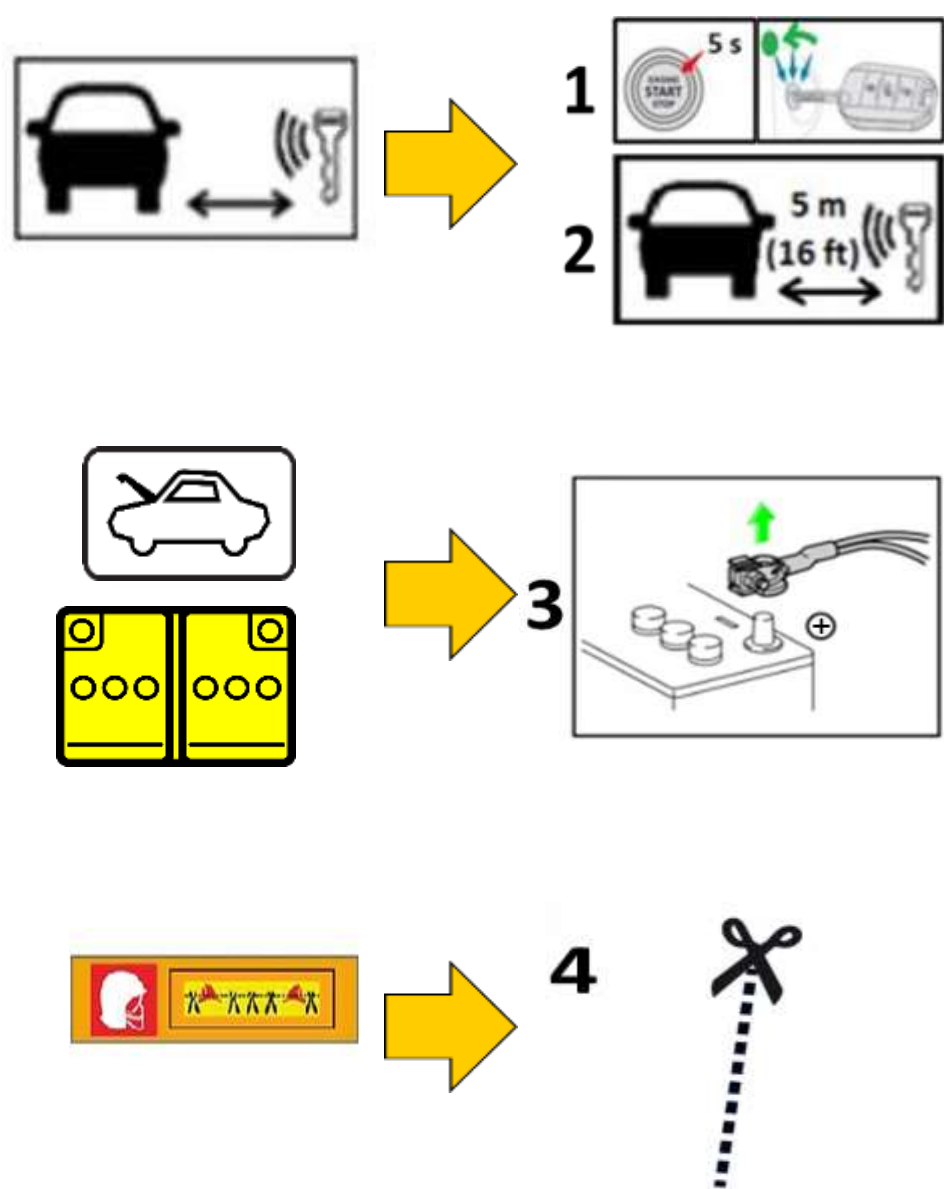

| STELLANTIS | ID N° | Version N° | Version date | Page |
|------------|------------------------------------|------------|--------------|------|
| | JEEP_Avenger__SUV_2023_5d_Electric | 1 | 21.03.2024 | 2/5 |

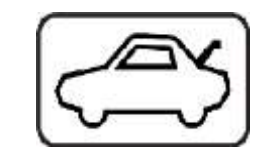

4. Access to the occupants

Glass types



Toughened glass



Laminated glass

High strength steel body

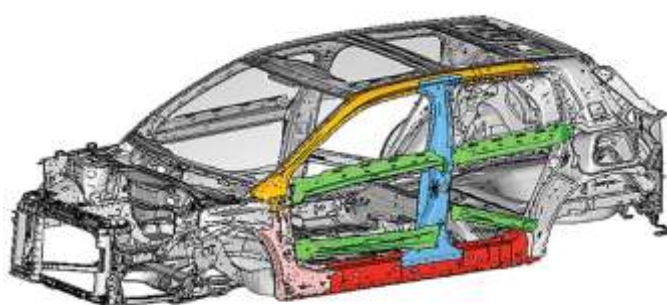

Seat adjustment

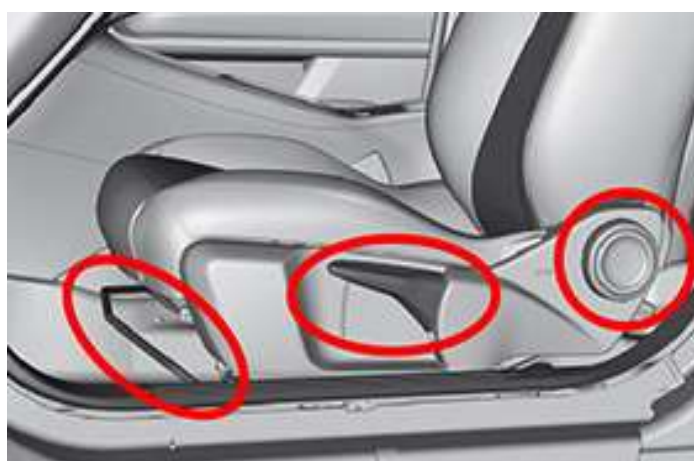

Steering column adjustment



5. Stored energy / liquids / gases / solids

| | | |
|--|-------------|--|
| | 12V | |
| | 400V | |
| | 0,9L | |



when coolant leaks from the battery pack, it can become unstable with risk of thermal runaway. Check battery pack temperature with thermal imaging camera.



6. In case of fire



Use large amount of water



RE-IGNITION POSSIBLE !



Lithium-ion batteries may self-ignite or reignite once the fire has been extinguished. Monitor the temperature of the high-voltage battery!

7. In case of submersion

3. Disable direct hazards / safety regulations

8. Towing / transportation / storage

Location front hook



Location rear hook



STORE AT SAFE DISTANCE FROM OTHER VEHICLES !

OK:



NOK:

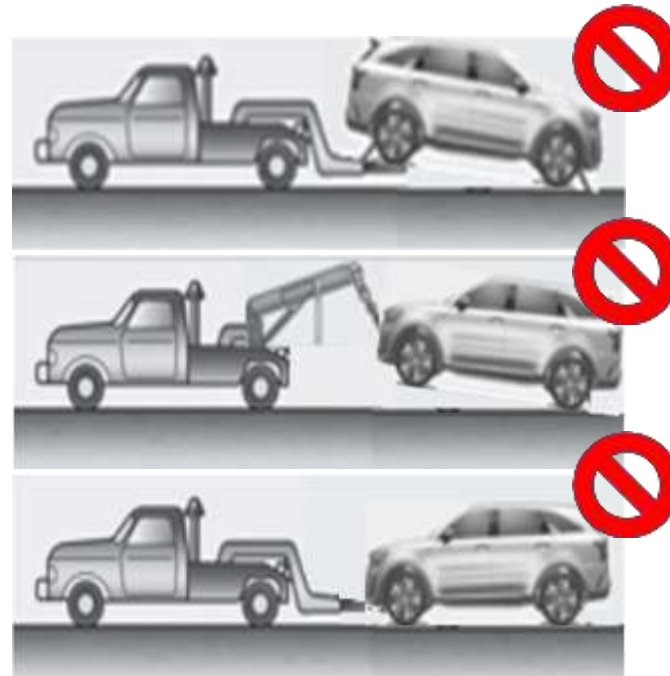















RE-IGNITION POSSIBLE !

| STELLANTIS | ID N° | Version N° | Version date | Page |
|------------|------------------------------------|------------|--------------|------|
| | JEEP_Avenger__SUV_2023_5d_Electric | 1 | 21.03.2024 | 4/5 |

9. Important additional information

-

10. Explanation of pictograms used

| | | | |
|---|-----------------------------|--|----------------------------------|
|  | Remove smart key |  | Flammable |
|  | General warning sign |  | Hazardous to the human health |
|  | Warning; low temperature |  | Acute toxicity |
|  | Warning, Electricity |  | Explosive |
|  | Air-conditioning component |  | Corrosives |
|  | Electric Vehicle |  | Use water to extinguish the fire |
|  | Use thermal Infrared camera |  | Bonnet |